

PANORA
FOR A BETTER VIEW

VERTICAL RETRACTING WINDOWS & DOORS

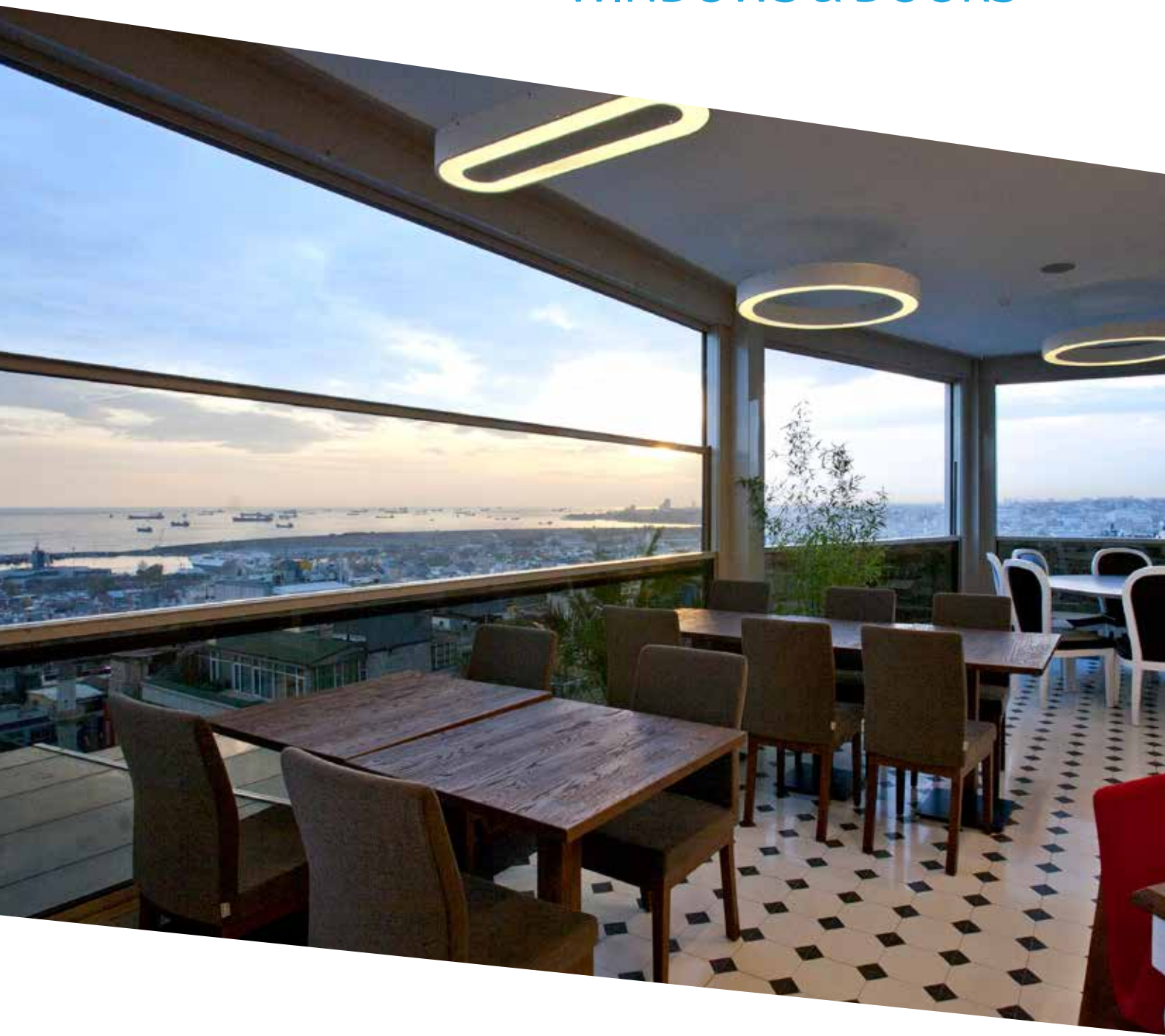

A division of



LIBART



PANORA
Vertical Retracting
Door Systems



PANORA
Vertical Retracting
Window Systems

A new solution for Windows & Doors “For a better view!”

We are proud to announce the revolution in Windows & Doors.

Libart's Panora Vertical Retracting Windows and Doors presents a new paradigm.

Panora's large span, vertical retracting Windows & Doors provide you with an unobstructed view within the structural supports in your buildings.

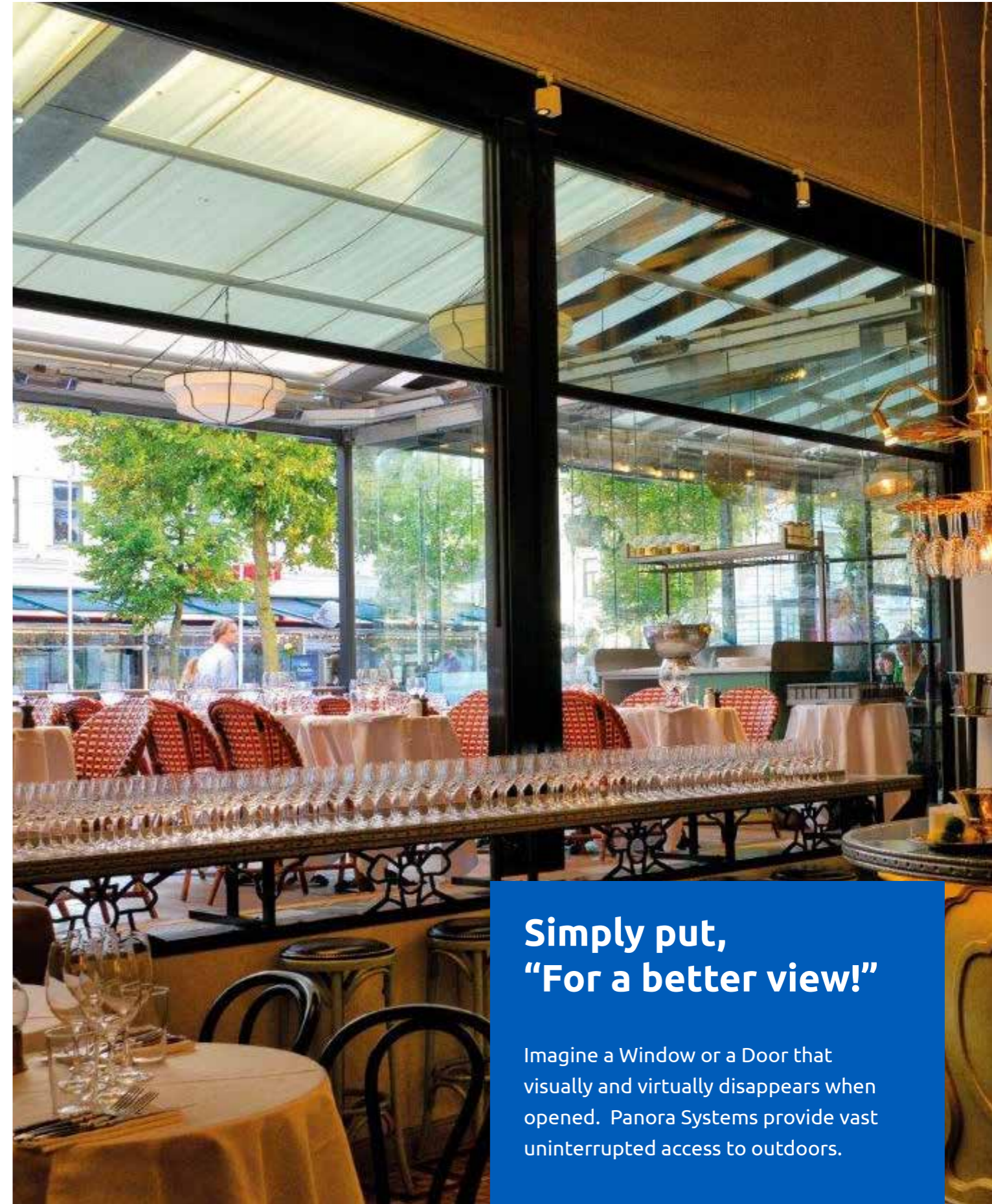

Simply put, “For a better view!”

Imagine a Window or a Door that visually and virtually disappears when opened. Panora Systems provide vast uninterrupted access to outdoors.

NEW APPROACHES FOR A BETTER VIEW!

BETTER VIEW

WHEN CLOSED

VIRTUALLY FREE OF FRAMES

MAXIMUM VIEW

WHEN OPEN

FREE OF FRAMES

Better View With Panora Vertical Retracting Door & Window

PANORA

Vertical Retracting Door & Window

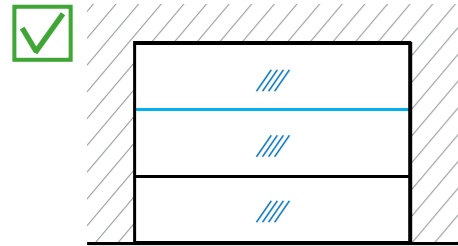

PANORA

Vertical Retracting Door & Window

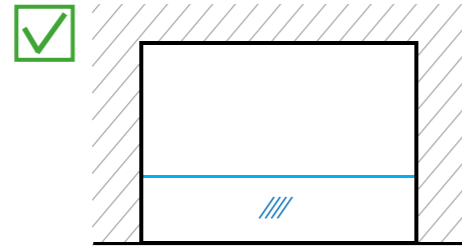

Limited View With Sliding And Folding Systems

TRADITIONAL Approaches

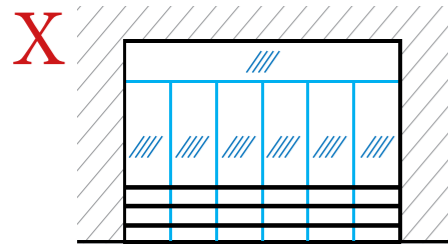

profiles in view when closed

TRADITIONAL Approaches

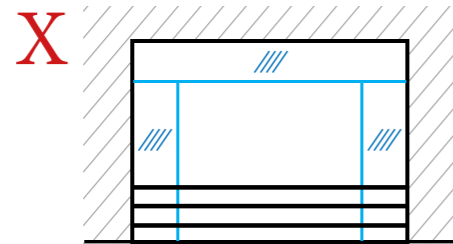

profiles in view when opened

BETTER VENTILATION

CLIMATE CONTROL

Better Ventilation Control With Panora Systems

Door Option

Window Option

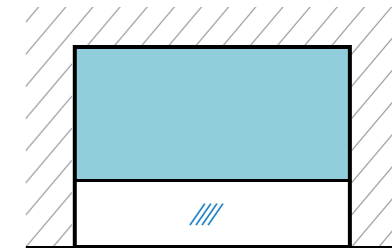
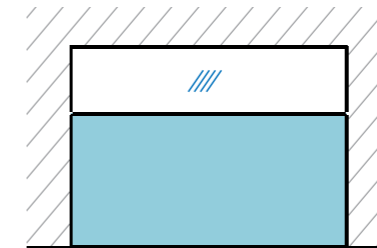
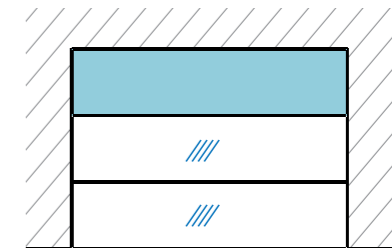
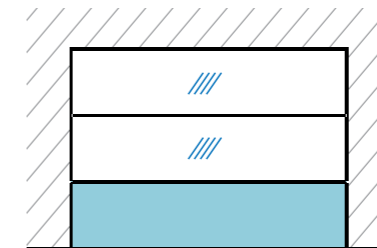
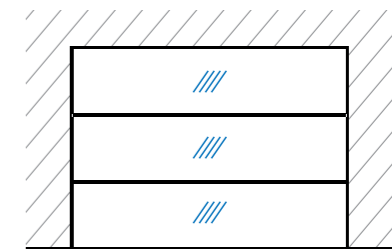
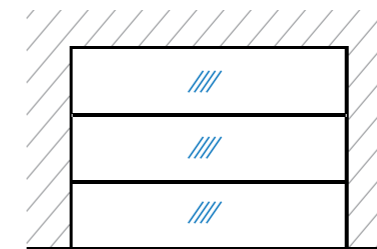

Panora can protect you from wind, while regulating the amount of fresh air.

VALUE OF VIEW

INDOOR COMFORT

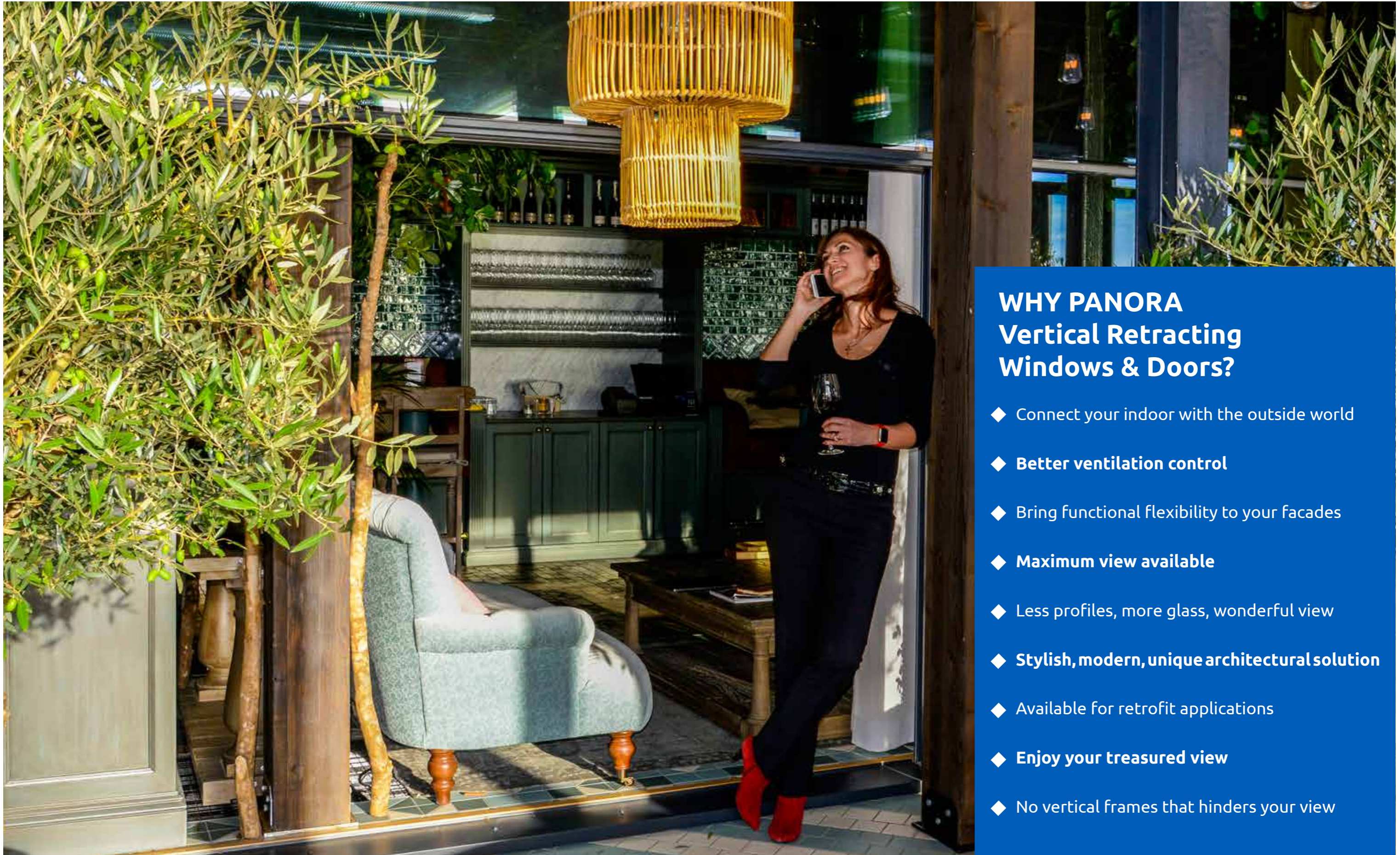

WHY PANORA Vertical Retracting Windows & Doors?

- ◆ Connect your indoor with the outside world
- ◆ **Better ventilation control**
- ◆ Bring functional flexibility to your facades
- ◆ **Maximum view available**
- ◆ Less profiles, more glass, wonderful view
- ◆ **Stylish, modern, unique architectural solution**
- ◆ Available for retrofit applications
- ◆ **Enjoy your treasured view**
- ◆ No vertical frames that hinders your view



CAROLINA ALE HOUSE

Project Code : # 4833
Location : USA
Size : 3.50 x 3.6 m
Operation Mode : W3 (Window)

Ale House is a successful restaurant chain in the USA. They wanted to create an outdoor atmosphere for their clients, while protecting their customers from changing weather conditions. Panora Vertical Retracting Windows create such an atmosphere, natural light, controllable airflow, unobstructed view. A natural microclimate solution. More window, less obstructions, higher customer satisfaction.

LONDON WALL PLACE

Project Code : # 2080
Location : United Kingdom
Size : 3 x 4 m (3 units)
Operation Mode : D4 (Door)

This Café required wide open counter space to blend the indoor space with the outside seating. Libart's Panora Vertical Retracting Windows flood the venue with natural light whilst maximizing clear opening without any loss interior or exterior space. Panora's minimalistic design complement area's blend of modern and ancient architecture. Open or closed provide a relaxing view of the landscaping at this oasis of calm in busy urban environment.

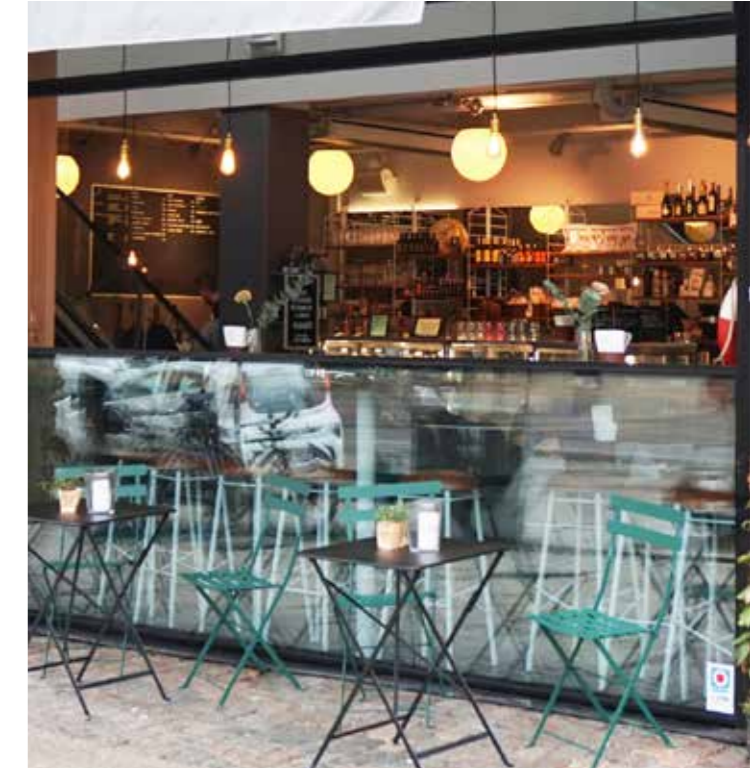

COOPERS HAWK LIBERTY

Project Code : # 2401
Location : USA
Size : 4 x 4 m (2 units)
Operation Mode : D4 (Door)

If you run a sports bar, you need the flexibility of adjusting your spaces when you can. With Panora Vertical Retracting Doors, inside venue can be integrated into the outdoor seating within minutes. Panora Door Systems can retract upwards to create unobstructed access, removing the barrier where there were once glass walls, simple connecting your indoor spaces with the out outdoors.

VALLGATAN COFFEE SHOP

Project Code : # 4126
Location : Sweden
Size : 4 x 2.8 m
Operation Mode : W2 (Window)

This special solution filled the architects and owners design dreams. Panora Window System provided wide open counter space as part of the interior counter extension when open, and full glass wall when closed. In this project a three frame Panora Window is used, with the top small glass fixed, middle retraction down.



BRASSERIE LIPP

Project Code : # 3487
Location : Sweden
Size : 3 x 3 m
Operation Mode : D3 (Door)

Classic sidewalk café, restaurant application. Client wanted to integrate their indoor spaces to their outdoor seating in good weather, while retaining maximum table space, ease of customer or server traffic. Libart's Panora Vertical Retracting Door's systems has provided this, large glass windows that retract up to provide obstruction free space between inside and outside, excellent alternative to classic sliding or folding doors & windows.



PANORA FAÇADE RESIDENCE

Project Code : # 3285
Location : Turkey
Size : 3.5 x 2.3 m - 4.1 x 2.3 m
Operation Mode : W2 (Window)

Comfort of your living spaces are greatly governed by your sense of spaciousness, this is where Panora windows play a big role, providing unobstructed view that blurs the inside with the outside. This project is an excellent example of how Panora vertical retracting Maxi Façade windows can transform a living room into an exclusive resting and refreshing space, with sea and countryside views from your favorite chair.

ONE SIZE DOES NOT SUIT ALL

Options to suit unique design needs and budgets.

PANORA MAX GUL

Cost-effective system, where extreme thermal insulation is not a priority, and cost is! 5 configurations, 2 or 3 frames (50%, 66% opening) Window, Door or Countertop, Sizes 3.5m width x 3.5m in height, operable frame weigh up to 190kg. New or retrofit installation with ease, Non-thermally broken profile system. Frames will accept Single or IG of up to 20mm.

PANORA MAXI GUM & GUM+

Residential & Commercial use, excellent weather & thermal performance, 6 configurations, 2, 3 or 4 frames (50%, 66% or 75% opening) Window or Door, Sizes 5.0m width x 5.0m in height, operable frame weigh up to 660kg, New or retrofit installation with ease, Designed with thermally broken structural system, motor box and window, Frames will accept Single or IG of up to 32mm.

PANORA FAÇADE GUF & GUF+

Curtain wall, Residential & Commercial use, excellent weather & thermal performance, 2 configurations (50% opening) Window or Door, Sizes 6.0m width x 4.5m in height. operable frame weigh up to 550kg, New or retrofit installation with ease. Designed with thermally broken structural system, motor box and window frames, Frames will accept IG of up to 38mm, 1.3 (W/m2K) with 0.8Ug triple glass option.

PANORA MAXIMA GUG+

Screw drive system for large span & weight, excellent weather & thermal performance, 4 configurations, 3 or 4 frames (66% or 75% opening) Window or Door, Sizes 6m width x 5m height, operable frame weigh up to 1000kg, New or retrofit installation with ease, Designed with thermally broken structural system, motor box and window frame, Frames will accept IG of up to 38mm, 1.3 (W/m2K) with 0.8Ug triple glass option.

VALUE FOR YOUR INVESTMENT

4 unique systems to suit specific needs, climates, sizes, or budget
Flexibility of configuration, safety features and aesthetics
Greater window and glass wall seating leads to greater revenue potential

Function
Open / close, button, remote or central automation systems, No need additional stacking space is required for stacking when opened, Uninterrupted openings of up to 6m (18'), no vertical profiles
Quality
Custom designed aluminum system (6063-T6), Electrostatic baked on powder coating, All components and fittings are of corrosion resistance materials, 25+ years of expertise in 40+ countries
Innovation
Alternative to sliding, swinging or folding windows & doors, More glass, less frame (up to 6m without vertical profiles), No counterweights, easy retrofit option

PANORA (GU) SYSTEMS PRODUCTION PROGRAM & OPTIONS

	MAX (GUL)	MAXI (GUM GUM+)	MAXI FAÇADE (GUF GUF+)	MAXIMA (GUG+)	
	Standard	Standard GUM	Optional GUM+	Standard	
Mechanical & Electrical	Motor & Input Voltage	120Nm Tubular, 220VAC/50hz	120Nm Tubular, 220VAC/50hz 300Nm Tubular, 220VAC/50hz	120Nm Tubular, 220VAC/50hz 300Nm Tubular, 220VAC/50hz	2 x 0.37kW 3-Phase Motors. 220VAC/50Hz
	Drive System	Direct chain drive, 12.7mm (1/2")	Proprietary gearbox chain drive, 12.7mm (1/2")		Double Vertical Screw Drive
	Open & Close Speed	2.2 m/min - 7.22 ft/min Toggle Switch (Non latching)	2.1 to 2.7 m/min - 6.9 to 9.0 ft/min 2.1 to 2.7 m/min - 6.9 to 9.0 ft/min	1.6 to 2.1 m/min - 5.4 to 7.0 ft/min 1.6 to 2.1 m/min - 5.4 to 7.0 ft/min	1.5 m/min - 4.9 ft/min
	Control System	Optional: Multi Channel Wireless Remote (6, 18, 99 channel) My Nice (BAS) integration	Optional: Multi Channel Wireless Remote (6, 18, 99 channel) My Nice (BAS) integration		Optional: Multi Channel Wireless Remote (6, 18, 99 channel), Rain Sensor, My Nice or other (BAS) integration via dry contacts
	Closed Door Lock	Standard: N/A Optional: Mechanical Latch (for Door version only)	Standard: N/A Optional: Mechanical Latch (for Door version only)		Not required due to screw drive design
	Safety Sensors	Standard: N/A Optional: One inferred safety sensor	Standard: One inferred safety sensor for Doors Optional: Light Barrier (exterior). Second inferred safety sensor		Standard: One inferred safety sensor Optional: Light Barrier (exterior). Second inferred safety sensor
	Motor Box Sizes (w x h)	125 x 125mm, (4.9" x 4.9")	162 x 210 mm, (6.4" x 8.3")		195 x 210 mm, (7.7" x 8.3")
	Design Options	2 sash 50%, 3 sash 66% opening Available as Window or Door	3 sash 66%, 4 sash 75% opening. Available as Window or Door		3 sash 66%, 4 sash 75% opening. Available as Window or Door
	Glazing	Standard: IG, 5T+10+5T mm, (3/16" T + 3/8" + 3/16" T) Optional: Single 6T mm T (3/16" T)	Standard: IG, 6T+20+6T mm, (1/4" T + 3/4" + 1/4" T) Max 32mm (1 9/32")		Standard: IG, 8T+20+8T mm, (5/16" T + 3/4" + 5/16" T) Optional: Triple 6T+10.5+5T+10.5+6T. Max 38mm (1 1/2")*
	Structural Support Fin Balustrade Bar	Optional: Single or Dual, 80 or 130mm (3 5/32" or 5 1/8")	Optional: Single or Dual, 80 or 130mm (3 5/32" or 5 1/8")		Optional: Single or Dual, 80 or 130 mm (3 5/32" or 5 1/8")
Structural	Operable Sash Weight	Optional, Windows Only Up to 190kg (419 lb.)	Optional, Windows Only 170 to 250 kg, (375 to 550 lb.) 250 to 660 kg, (375 to 1450 lb.)		Optional, Windows Only Up to 1000 kg (2200 lb.)
	Max Width & Height	3.5 x 3.5 m, (137" x 137")	5.0 x 5.0 m, (196" x 196")		6.0 x 5.0 m, (236" x 196")
	Min Width	1.2 m (48")	1.8 m (63")		1.8 m (63")
	Weather Seals	Silent-fin Brush Pile with PVC Fin & EPDM seals	Silent-fin Brush Pile with PVC fin & EPDM seals		Silent-fin Brush Pile with PVC fin & EPDM seals
	Profile Type	Non-thermally broken; Motor box, Sash, Jamb All aluminum 6063-T6 alloy	Thermally broken; Motor box, Sash, Jamb All aluminum 6063-T6 alloy		Thermally broken; Motor box, Sash, Jamb All aluminum 6063-T6 alloy
	Surface Finish	Electrostatic baked-on powder coating	Electrostatic baked-on powder coating		Electrostatic baked-on powder coating
	System Color	5 standard RAL colors (7024, 9005, 9010, 9006, 1019)	Standard RAL (8003, 9005, 9010, 1019, 7016, 8014, 9006, 7024) Optional: Other RAL colors & Custom colors		Standard RAL (8003, 9005, 9010, 1019, 7016, 8014, 9006, 7024) Optional: Other RAL colors & Custom colors
	Watertightness EN 12208	Class 5A (at 250 Pa)	Class 6A (at 250 Pa)		Class 7A (at 300 Pa)
	Resistance to Safety Load EN 12210	OK (at +800 Pa) ; OK (at -800 Pa)	OK (at +1800 Pa) ; OK (at -1800 Pa)		OK (at +1800 Pa) ; OK (at -1800 Pa)
	Air Permeability EN 12207	Class 2 (at +600 Pa) ; Class 2 (at -600 Pa)	Class 3 (at +600 Pa) ; Class 3 (at -600 Pa)		Class 3 (at +600 Pa) ; Class 3 (at -600 Pa)
Standards	Resistance to Wind Load EN 12210	Class B2 (at +800 Pa) ; Class B2 (at -800 Pa)	Class C3 (at +1200 Pa) ; Class C3 (at -1200 Pa)		Class C3 (at +1200 Pa) ; Class C3 (at -1200 Pa)
	Maximum Thermal Insulation	Uw = 2.4 W/m2K. (IG 5T+10+5T mm)	Uw = 1.6 W/m2K, (with Ug = 1.1 IG)		Uw = 1.45 W/m2K, (with Ug = 1.1 glass) Optional: Uw = 1.3 W/m2K, (Ug = 0.8 W/m2K with Triple IG)*

*Please consult your project representative for technical details.

PANORA MAX (GUL)

Cost effective system with good weather performance, ideal for installations where extreme thermal insulation is not a priority and cost is

Up to 5 different configurations, 2 to 3 frames allowing for 50%, 66% opening as a Window, Door, Interior Divider or Countertop Applications

Operable glazed frame weight up to 190 kg, sizes ranging from 3.5m width to 3.5m in height

Structural fin support system for strong wind support, balustrade option for Window models

Minimalistic frames 125mm deep x 76mm Jamb, and 40mm frames

New or retrofit installation with ease, no need for special gutter or hidden counterweights

Designed with non-thermally broken profile system, Frames will accept single or IG of up to 20mm

Extensive control options inclusive of connection to building automation

Design & Safety

"Hidden Sash Guide" for esthetics and "Finger pinch" for safety, Minimalistic Sash and Jamb profiles, No counterweight system resulting narrow jamb and ease of install, especially for retrofit, Safety options; toggle SW, single or double safety beam

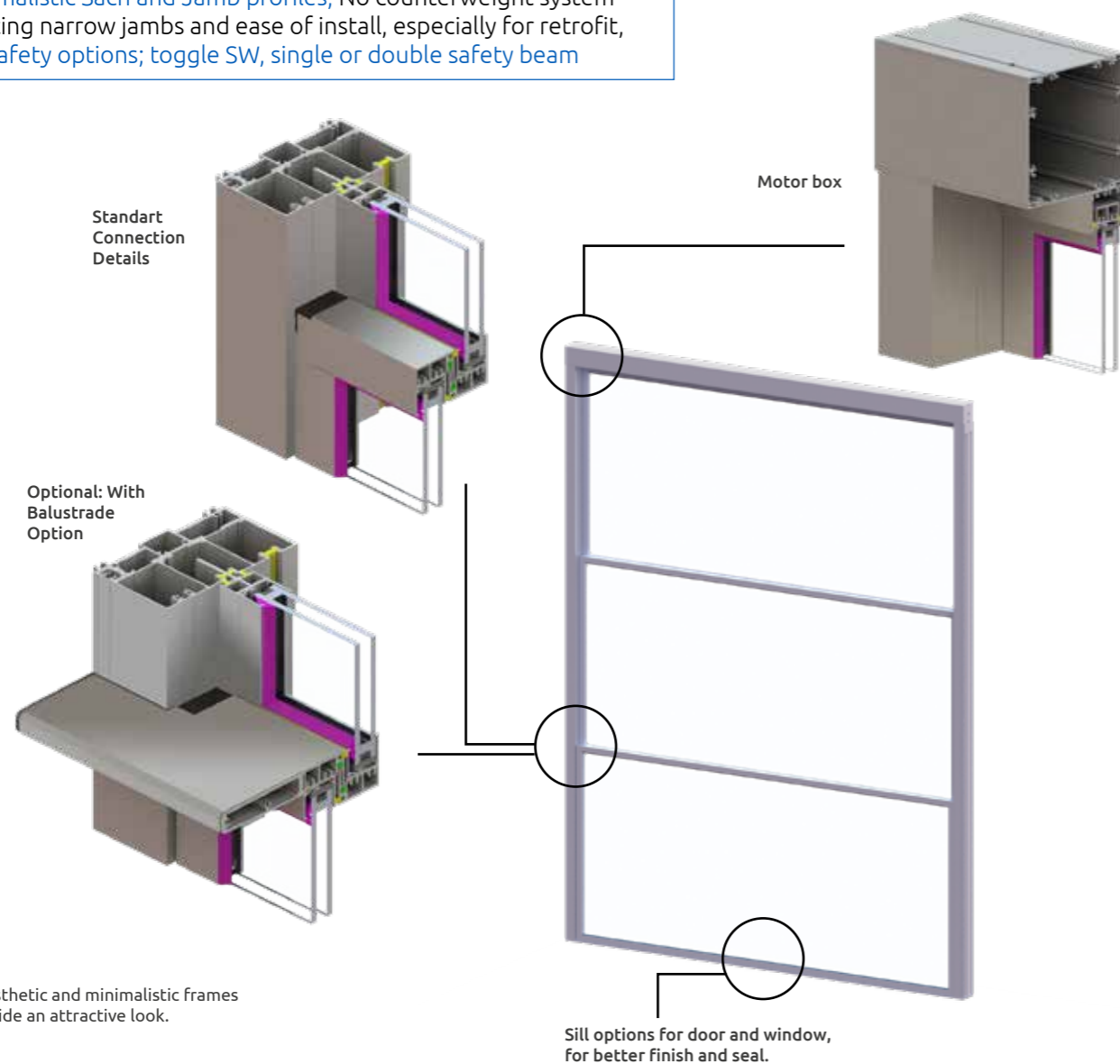

• Aesthetic and minimalistic frames provide an attractive look.

Sill options for door and window, for better finish and seal.

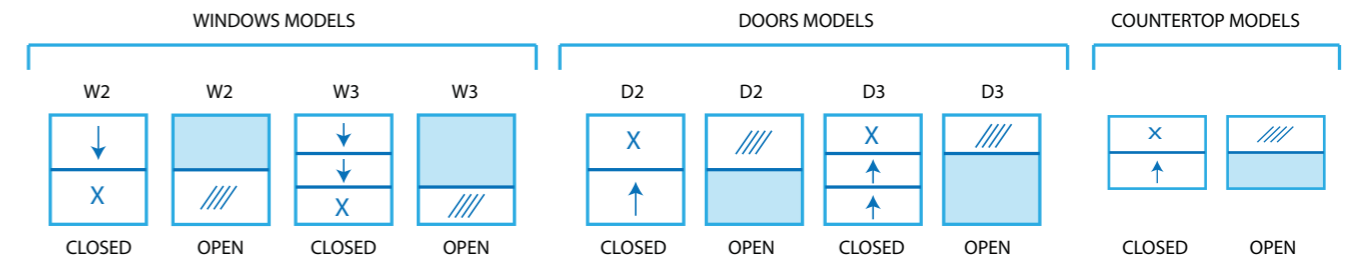

PANORA MAX-GUL W3

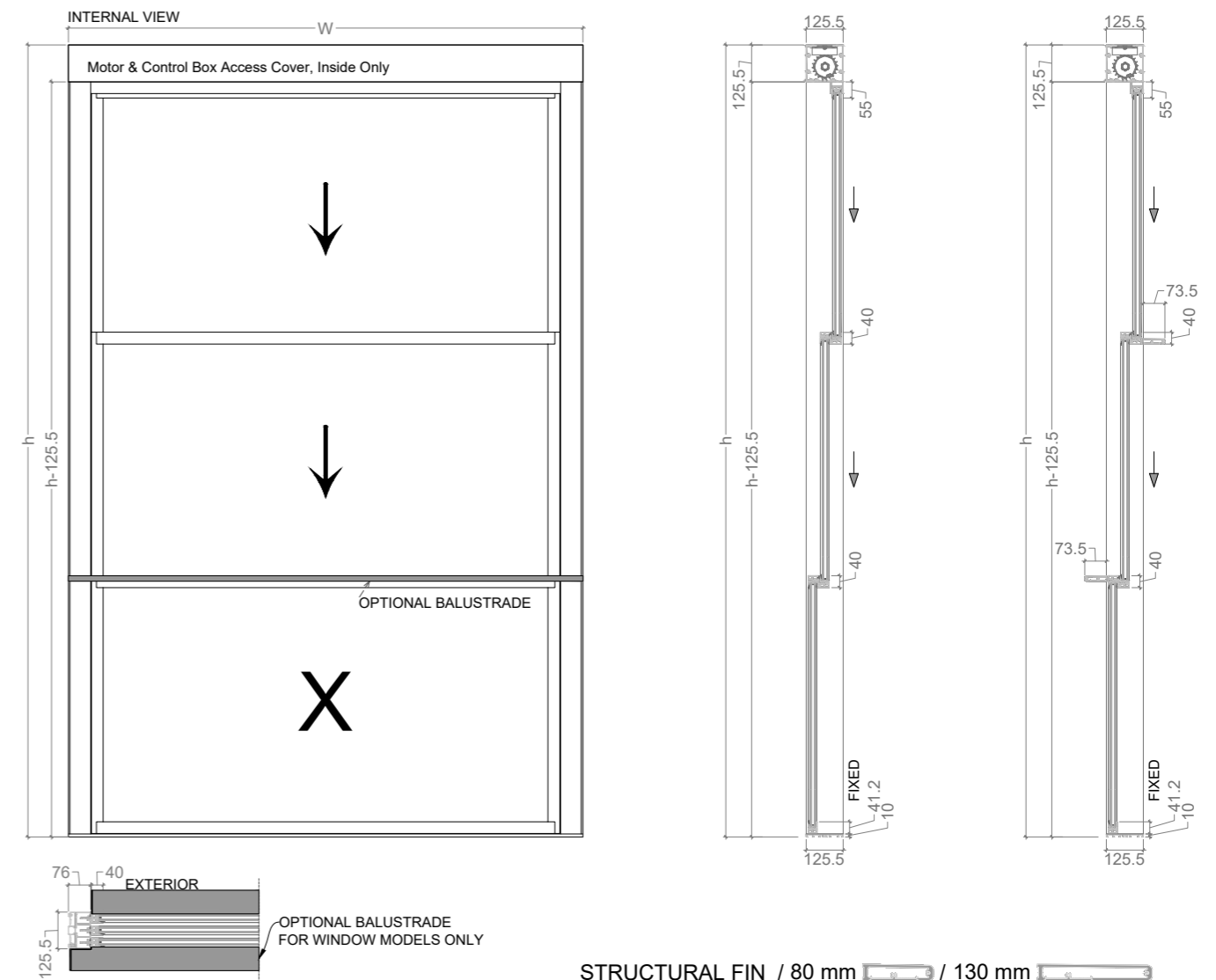

Total operating glazed frame weight should not exceed over 190kg.

GUL systems are available with or without glazing. Frames can be locally glazed by installers.

*Maximum operable dimensions are dependent on the operable glazed frame weight.

**Maximum thermal insulation is possible with high performance glass. Ask your project consultant for information.

PANORA FAÇADE (GUF & GUF+)

Designed for curtain wall or residential applications where excellent weather and thermal performance is of importance

2 frame system allowing for 50% opening as a window or a door

Operable glazed frame weight up to 550 kg

Sizes ranging from 6.0m width to 4.5m in height

Structural fin support system for strong wind support

Balustrade option for Window models

Minimalistic frames 125mm deep x 68mm Jamb, and 40mm frames

New or retrofit installation with ease, no need for special gutter or hidden counterweights

Up to 1.3 W/m²K Uw value with triple glass option.

Designed with thermally broken structural system, motor box and window frames to provide excellent insulation,

Frames will accept IG of up to 38mm

Extensive control options inclusive of connection to building automation

Class 7A in watertightness based on EN12208

Design & Safety

“Hidden Sash Guide” for esthetics and “Finger pinch” for safety, Minimalistic Sash and Jamb profiles, No counterweight system resulting narrow jams and ease of install, especially for retrofit, Safety options; toggle SW, single or double safety beam

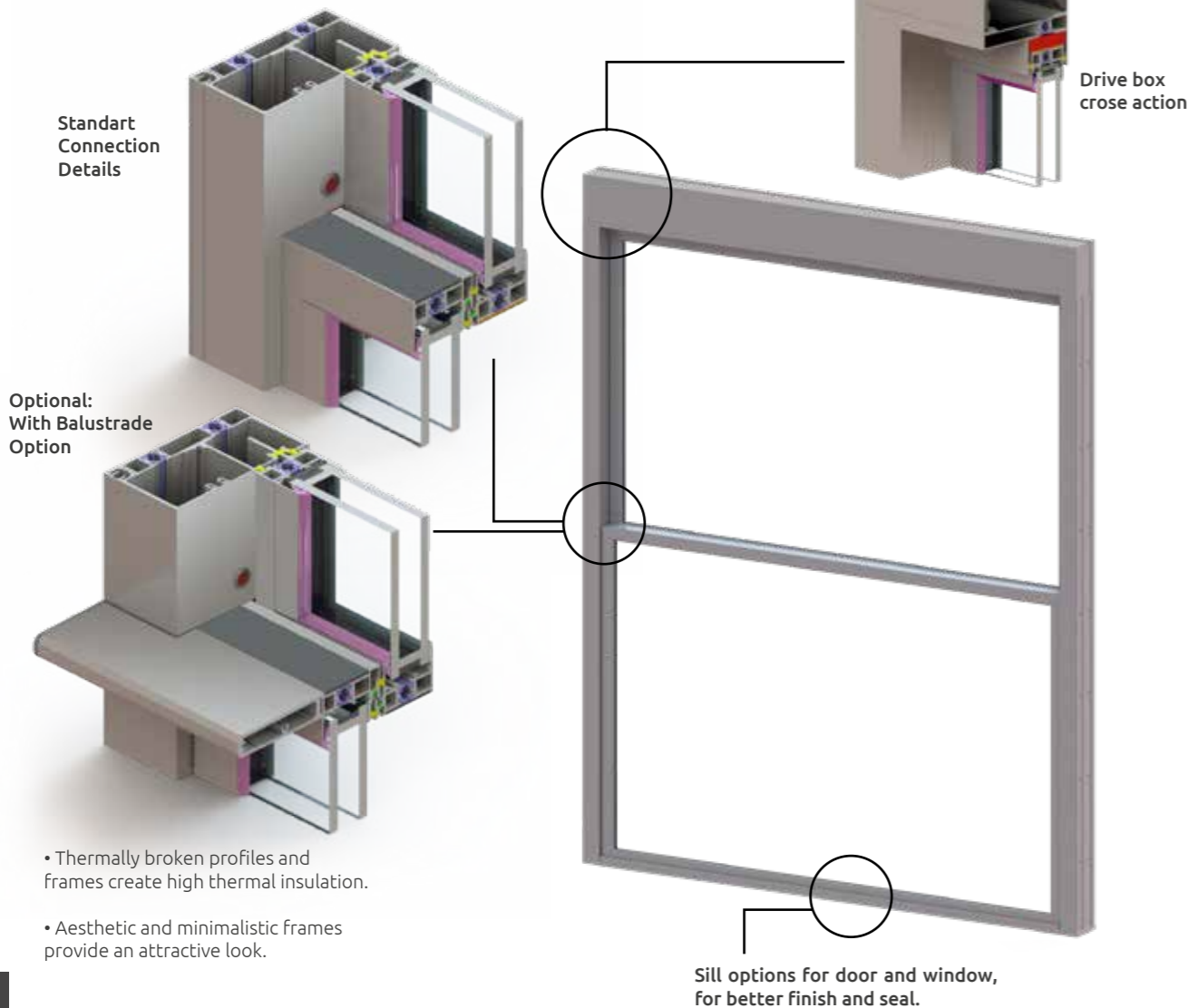

• Thermally broken profiles and frames create high thermal insulation.

• Aesthetic and minimalistic frames provide an attractive look.

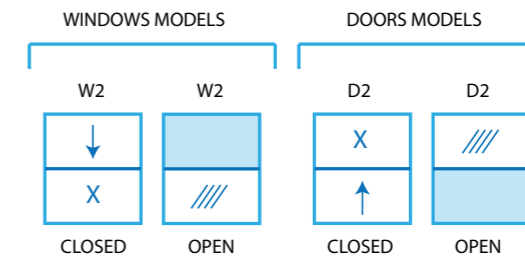

PANORA FAÇADE - GUF/GUF+ W2

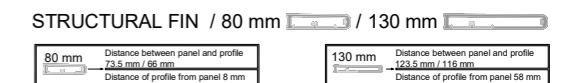
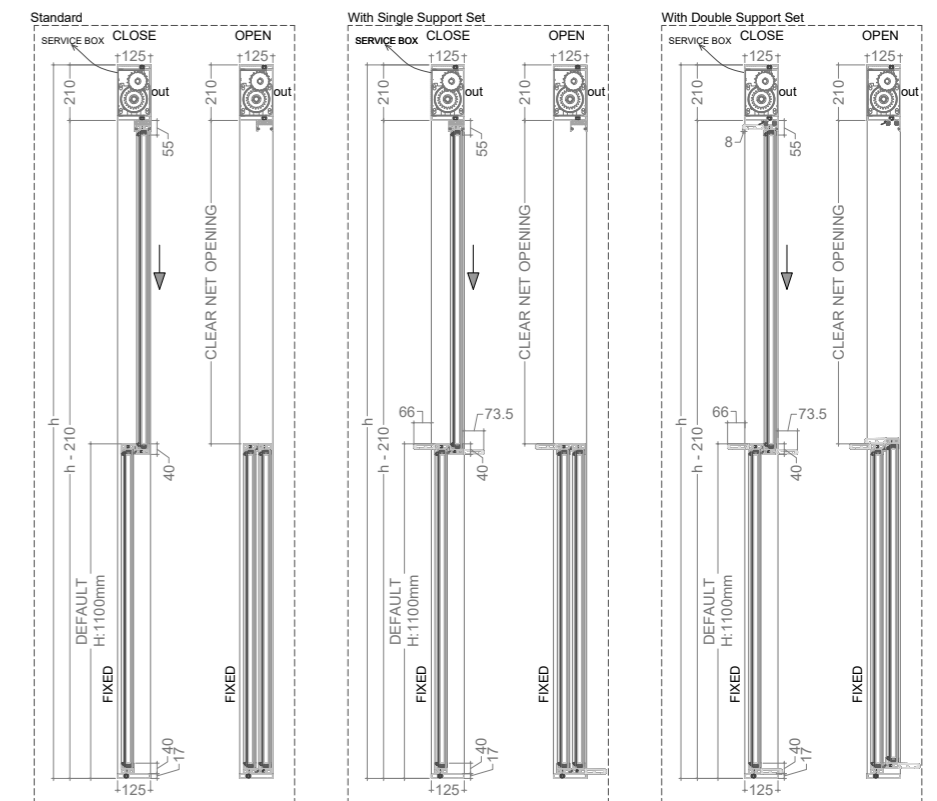
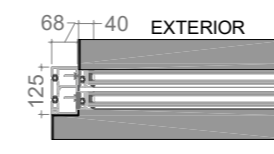
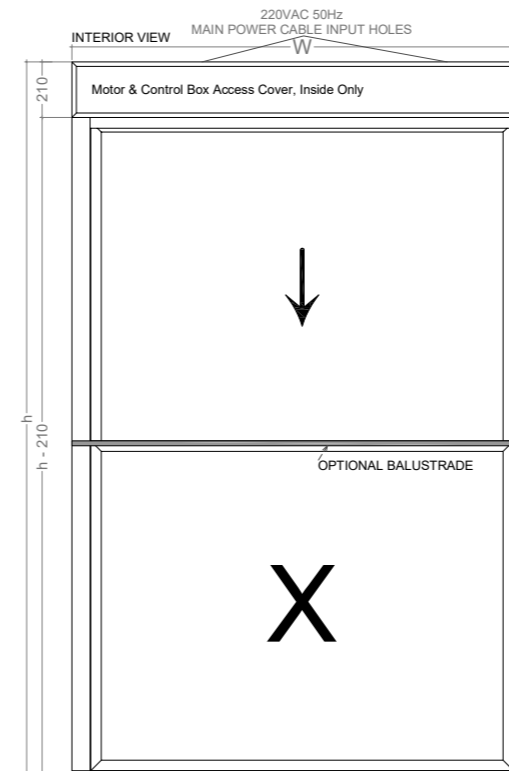

Total operating glazed frame weight should not exceed over 550kg.

GUF systems are available with or without glazing. Frames can be locally glazed by installers.

*Maximum operable dimensions are dependent on the operable glazed frame weight.

**Maximum thermal insulation is possible with high performance glass. Ask your project consultant for information.

PANORA MAXIMA (GUG+)

Ideal for large spans of up to 6m, excellent thermal insulation. Industry leader screw drive, advanced PLC based control system that sets industry standards in safe operation and control flexibility.

Sizes ranging from 6m width to 5m height and total operable weigh limit 1000 kg.

Designed with thermally broken structural system, motor box and window frame.

4 different Window or Door configurations available in 66% and 75% net balustrade option for window model.

New or retrofit installation with ease frames will accept IG of up to 38mm

Up to 1.3 W/m²K Uw value with triple glass

Class 7A according to EN 12208

Class C3 according to EN 12210

Extensive control options inclusive of connection to building automation

Design & Safety

“Hidden Sash Guide” for esthetics and “Finger pinch” for safety, Minimalistic Sash and Jamb profiles, No counterweight system resulting narrow jams and ease of install, especially for retrofit, Safety options; toggle SW, single or double safety beam

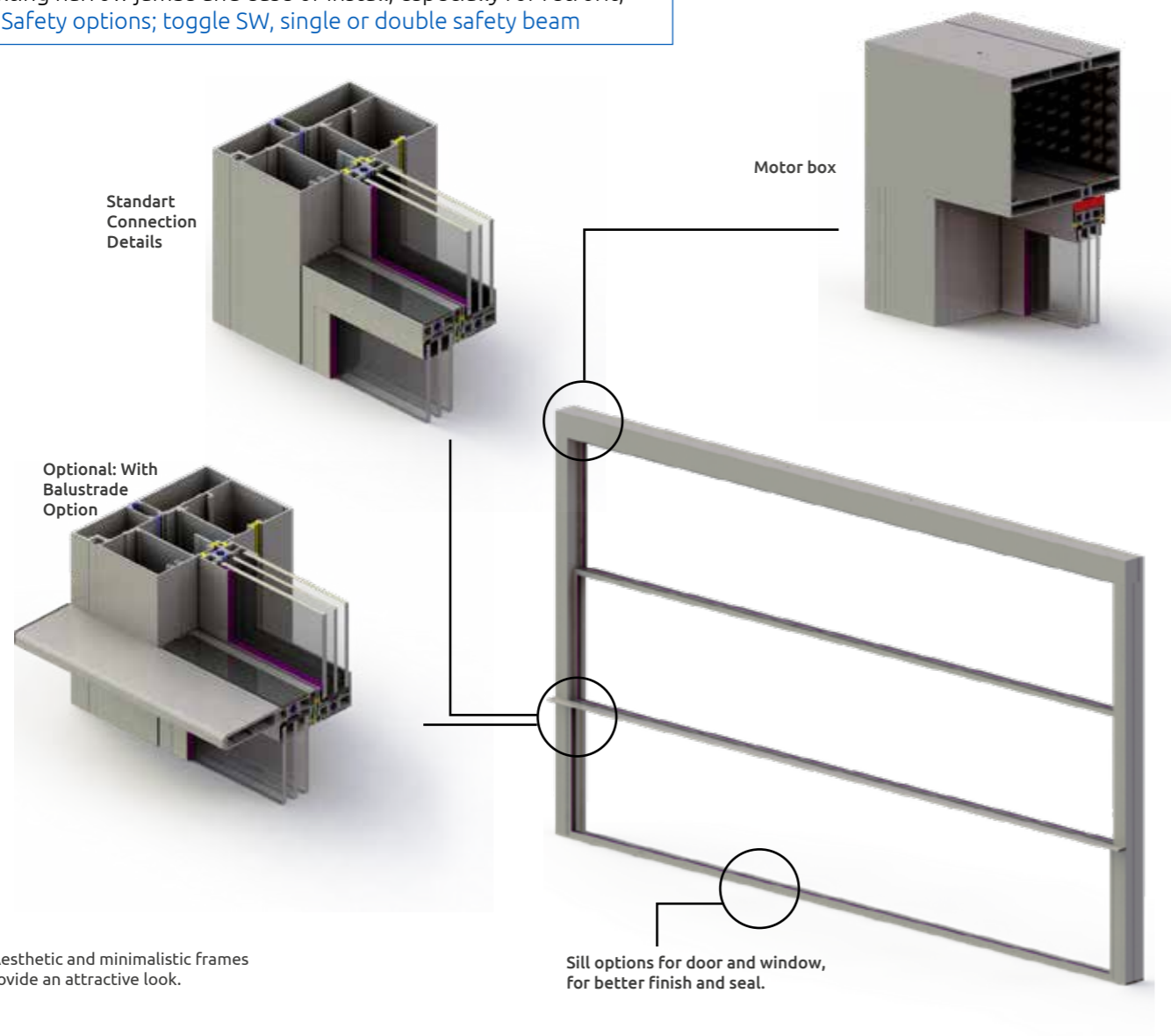

• Aesthetic and minimalistic frames provide an attractive look.

Sill options for door and window, for better finish and seal.

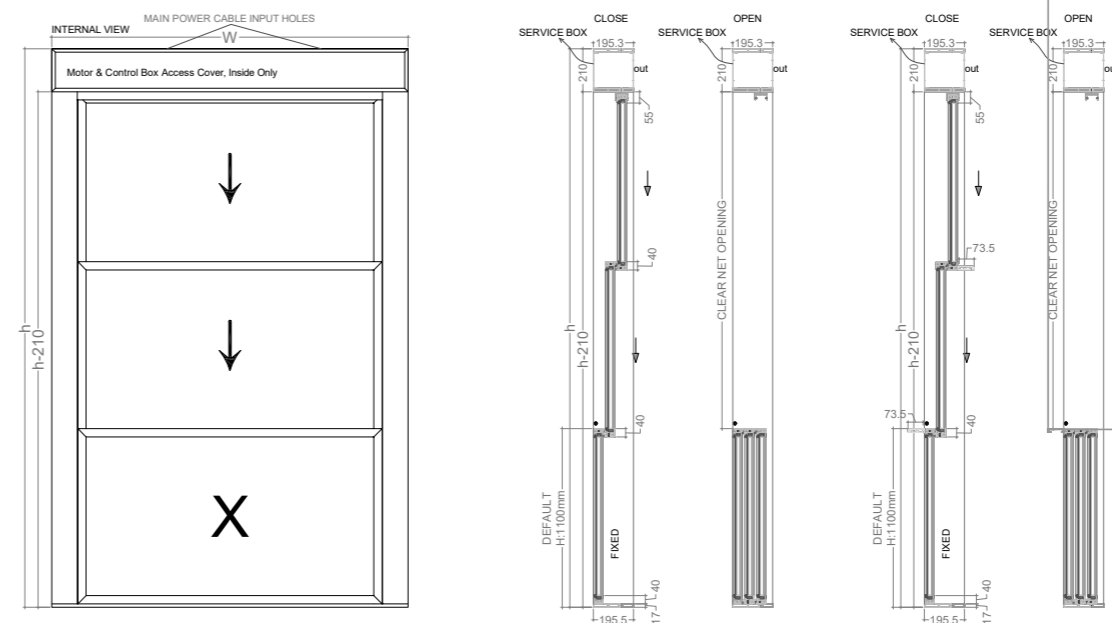
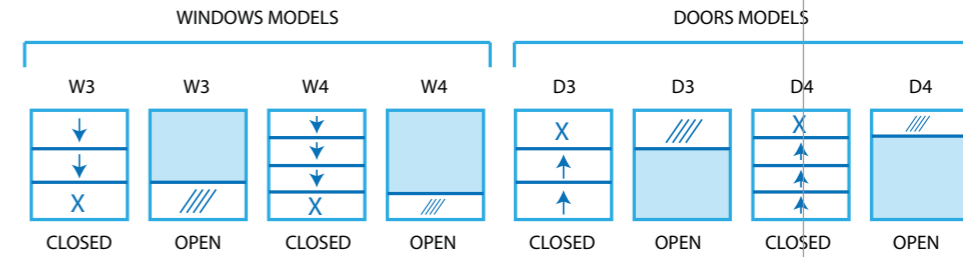

Total operating glazed frame weight should not exceed over 1000kg.

GUG+ systems are available with or without glazing. Frames can be locally glazed by installers.

*Maximum operable dimensions are dependent on the operable glazed frame weight.

**Maximum thermal insulation is possible with high performance glass. Ask your project consultant for information.



6623



4850

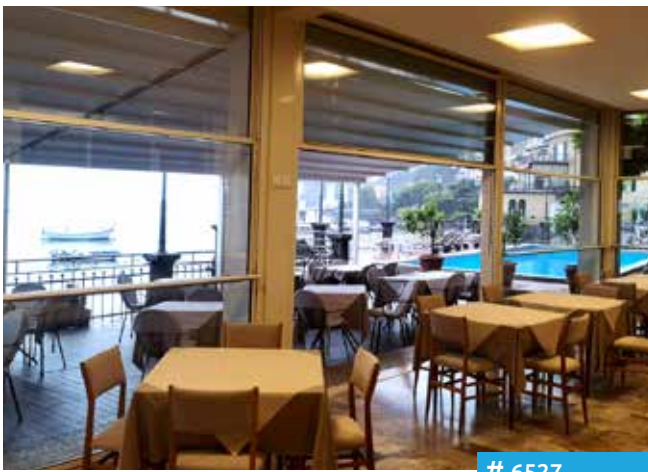

6527



5345

Libart designs and fabricates operable architectural systems for discerning architects and professional clients from around the world. Libart's aluminum and glass retractable structures are innovative, functional and aesthetically attractive. They are used in restaurants, cafes, hotels, commercial and residential and industrial facilities. Our commitment to research, design, engineering and manufacturing is based on providing our customers value added retractable structures that offer flexible living and working environments, for any type of weather.

Libart has been serving the architectural industry with operable solutions for over 25+ years, with manufacturing centers located in 3 continents and dealers in more than 40+ countries.

To learn more about our systems and projects from around the world please visit and contact us via www.panorasystems.com

✉ sales@panorasystems.com



/libartinternational